

## Folha de dados | Número do item: 221-500

Base de montagem; Linha 221 - 4 mm<sup>2</sup>; montagem em trilho DIN 35  
/montagem com parafuso; laranja

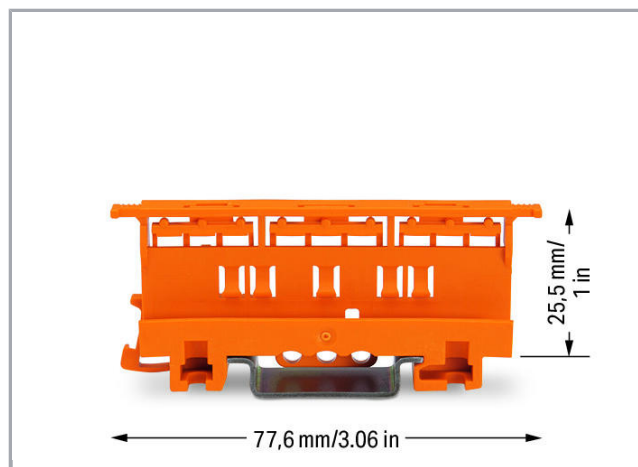

[www.wago.com/221-500](http://www.wago.com/221-500)

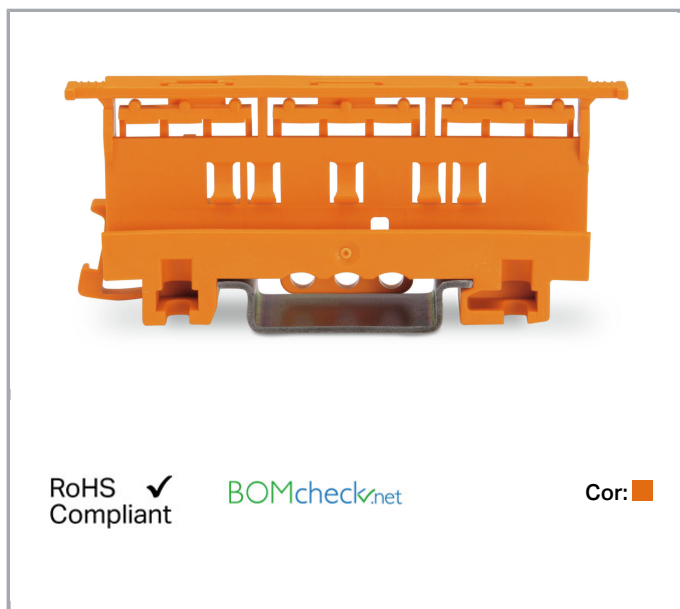

### Dados

#### Dados geométricos

Largura	17,5 mm / 0.689 inch
Altura da borda superior do trilho DIN -35	25,5 mm / 1.004 inch
Profundidade	77,6 mm / 3.055 inch

#### Dados do Material

Cor	laranja
Material isolante	Poliamida 66 (PA 66)
Peso	9,6

#### Dados Comerciais

Tipo de embalagem	BOX
País de origem	CN
GTIN	4055143421942
Customs Tariff No.	39269097900

### Produtos Compatíveis

#### Marking accessories



Nº. do item: 210-833

Faixas de identificação; em rolo; 6 mm de largura; liso; auto-adesiva; branco

[www.wago.com/210-833](http://www.wago.com/210-833)

---

#### Mounting adapter

Nº. do item: 222-505

Placa liberadora de tensão; para trilho de montagem; Linhas 221 ou 222, podem ser encaixadas

[www.wago.com/222-505](http://www.wago.com/222-505)

Nº. do item: 222-510

Adaptador de trilho DIN angulado; em combinação com suporte de montagem; 221-500 ou 222-500; Para montagem em trilho DIN-35; cinza

[www.wago.com/222-510](http://www.wago.com/222-510)

---

#### Downloads

##### Documentação

##### Informações adicionais

Technical explanations

03/04/2019

pdf  
2,1 MB

[Download](#)

---

#### Dados CAx

##### Dados CAD

2D/3D Models 221-500

[URL](#)

[Download](#)

---

##### CAE data

EPLAN Data Portal 221-500

[Download](#)

---

## Installation Notes

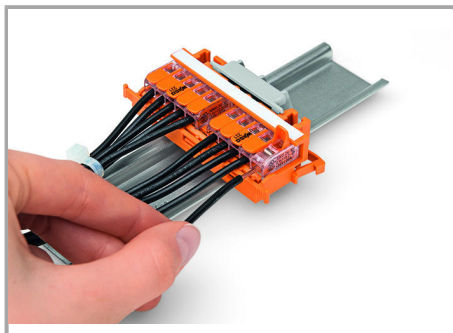

CAGE CLAMP® connection:

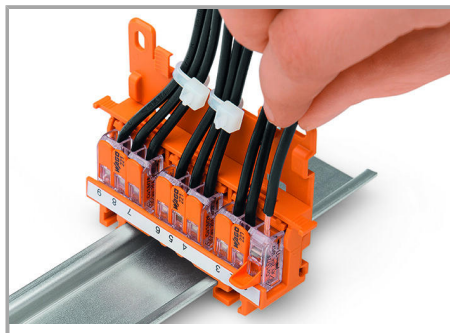

Removing a conductor.

Conductor termination with connectors fitted in a mounting carrier

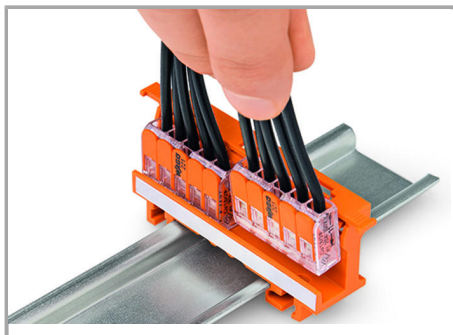

Inserting a connector into the mounting carrier.



Inserting a connector into the mounting carrier.

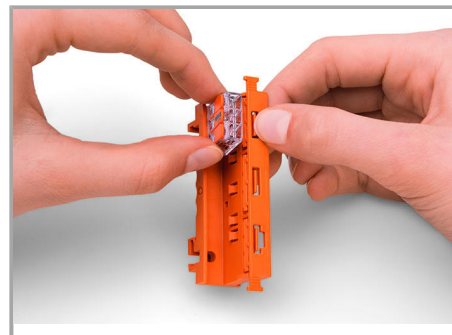

Removing a connector from the mounting carrier.

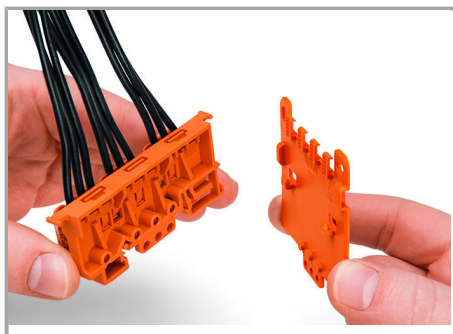

Securing a strain relief plate (222-505) to the mounting carrier.  
Sujeito a alterações.

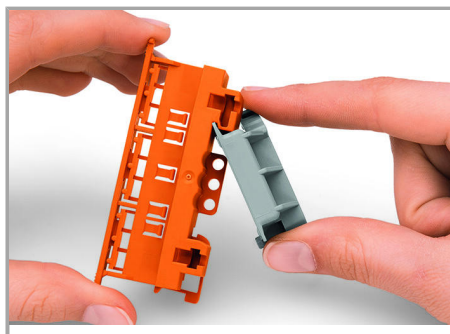

Snapping the angled DIN-rail adapter (222-510) onto the mounting carrier.



Horizontal mounting on DIN-35 rail using an angled DIN-rail adapter.

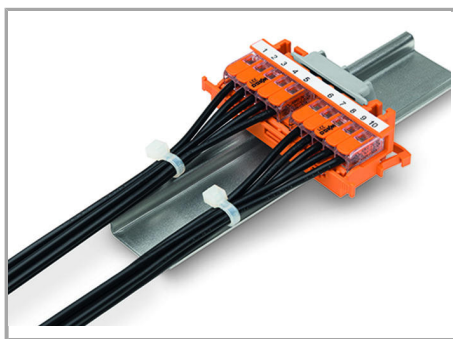

Horizontal mounting on DIN-35 rail using an angled DIN-rail adapter.

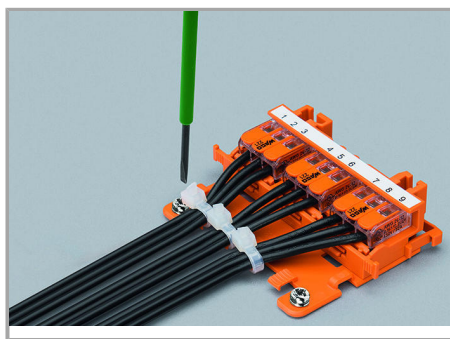

Horizontal screw mounting with strain relief plate on a flat surface



Vertical mounting with strain relief plate on DIN-35 rail.

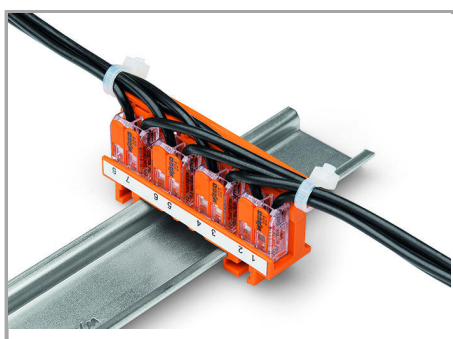

Strain relief via cable ties on the mounting carrier (transverse to the connectors' wiring direction) – clamping units labeled via marking strips (210-334).

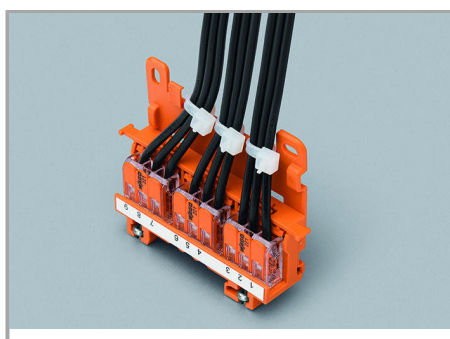

Vertical screw mounting with strain relief plate on a flat surface.

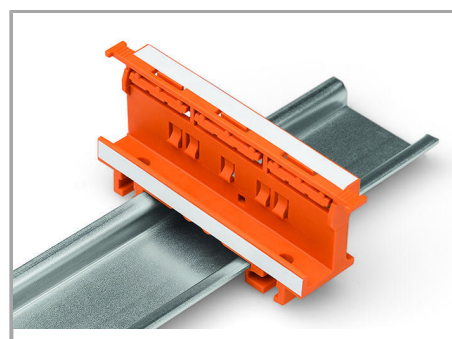

Mounting carrier on a DIN-35 rail

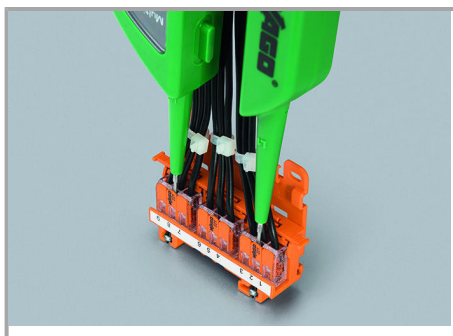

Testing connectors via test slots on top of the carrier.

Sujeito a alterações.

WAGO Eletroeletrônicos Ltda  
Rua Trípoli, 640, Loteamento Multivias II  
Jardim Ermida I, Jundiaí - SP, CEP: 13212-217  
Tel.: +55 (11) 2923-7256  
Email: [info.br@wago.com](mailto:info.br@wago.com)

Alguma dúvida sobre nossos produtos?  
Será um prazer atender a sua chamada no +55 11 2923-7200.